

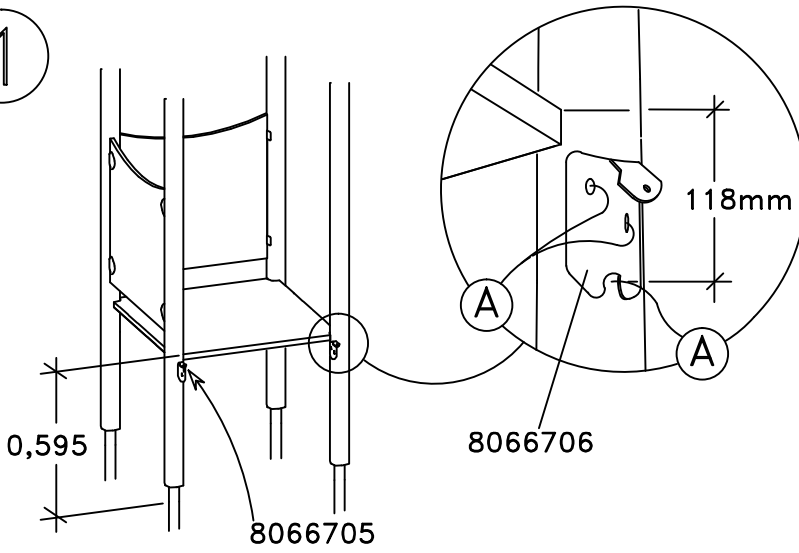











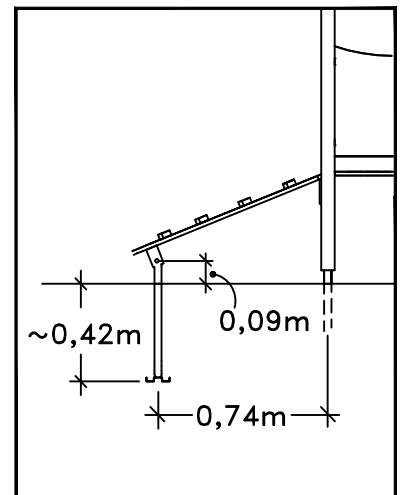
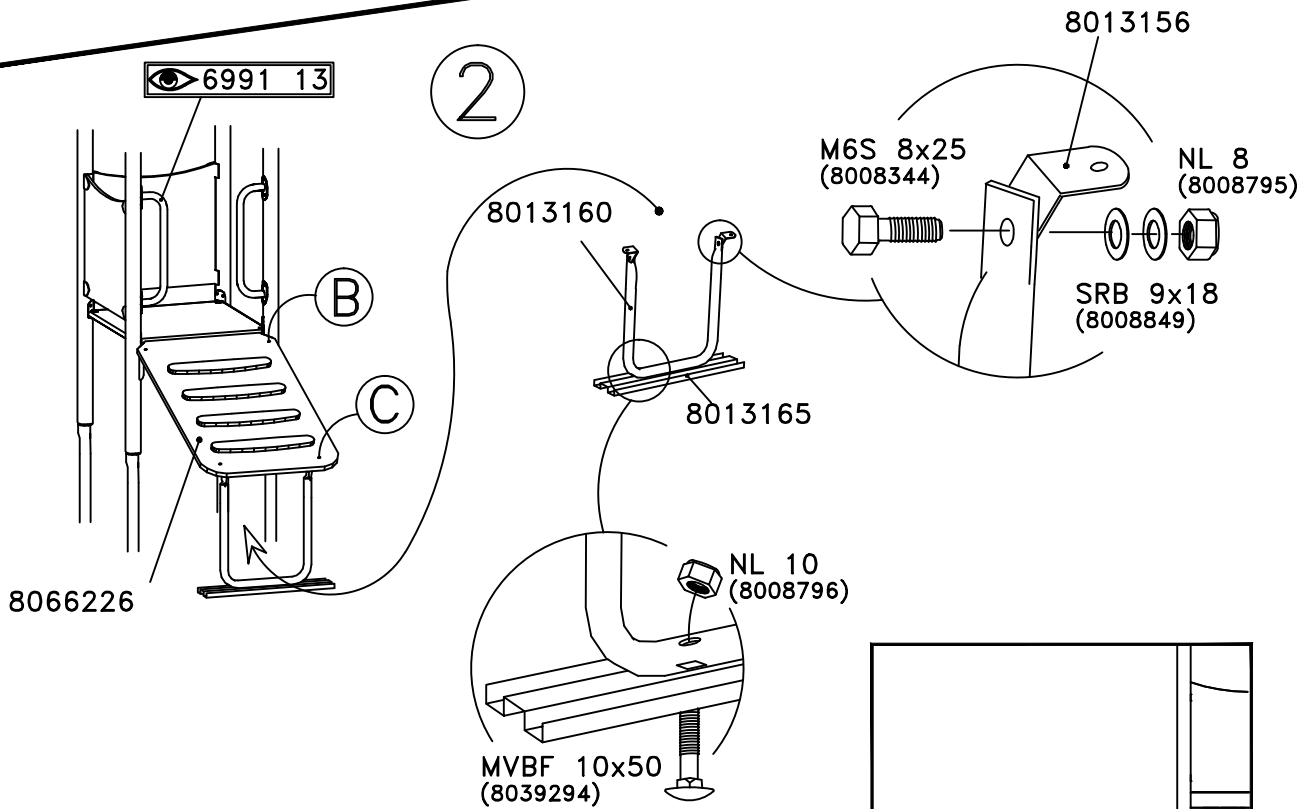

1

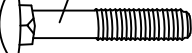
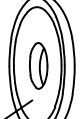

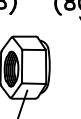

TYPE	HAGS.NO
 0,67x0,98m	8066226
 0,43x0,51m	8013160
 L=0,62m	8013165

2



A	TKFT 6x38 (8008651)  15/7x3(8x) (8035290) 
B	MVBF 6x30 (8039271)  DISTANCE 6 (8005953)  CAP 6 (8005951)  SRB 7x14 (8008848)  COVER 6 (8005952)  NL 6 (8008794) 
C	MVBF 6x30 (8039271)  CAP 6 (8005951)  SRB 7x14 (8008848)  NL 6 (8008794)  COVER 6 (8005952) 

<b>HAGS</b>	ANEBY, SWEDEN +46(0)380-47300 www.hags.com
Ramp 6121 10	
   2017-10-19 1	